

HOSHIZAKI

Series

KM500M_H
Item # 13036 02/04

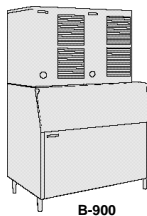
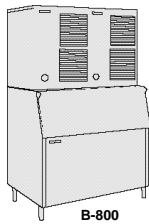
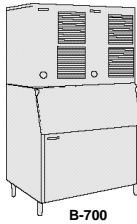
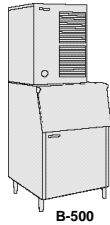
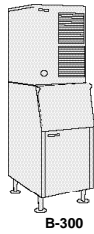

KM-500M_H SERIES



KM-500MAH Cuber
Shown on Optional
B-300 Bin

KM-500MAH
Air-Cooled
KM-500MWH
Water-Cooled
KM-500MRH
Air-Cooled Remote

ICEMAKER DIMENSION	
Width x Depth x Height	
KM-500M_H	
22 x 27 ³ / ₈ x 30 ⁵ / ₁₆ "	
DIMENSION BY BIN SIZE	
Width x Depth x Height	
B-300	22 x 32 ¹ / ₂ x 76 ⁵ / ₁₆ "
B-500	30 x 32 ¹ / ₂ x 76 ⁵ / ₁₆ "
B-700	44 x 32 ¹ / ₂ x 76 ⁵ / ₁₆ "
B-800	48 x 32 ¹ / ₂ x 76 ⁵ / ₁₆ "
B-900	52 x 32 ¹ / ₂ x 76 ⁵ / ₁₆ "

- Durable stainless steel exterior
- CycleSaver® design 
- EverCheck® alert system 
- Up to 517 lbs. of ice production per 24 hours
- Individual crescent cube
- Stainless steel evaporator
- Mount two units side-by-side, in only 44" of floor space, for 1,034 lbs. per 24 hours
- Removable air filters

© HOSHIZAKI AMERICA, INC.

618 Hwy. 74 S., Peachtree City, GA30269

TEL1-800-438-6087

FAX 1-800-345-1325

www.hoshizaki.com



Reliability is a beautiful thing™

SLIM-LINE MODULAR CRESCENT ICE CUBER

KM-500M_H SERIES

DIMENSIONS (Inches) - CONNECTIONS



- KM-500MAH** (AIR-COOLED)
- KM-500MWH** (WATER-COOLED)
- KM-500MRH** (AIR-COOLED REMOTE)

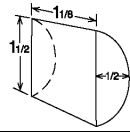

- Up to 517 lbs. of ice production per 24 hours
- Mount two units side-by-side for 1,034 lbs. per 24 hours

WARRANTY
THREEYEAR - Parts & Labor on entire machine.
FIVEYEAR - Parts & Labor on : Evaporator
FIVEYEAR - Parts on: Compressor, Air-Cooled Condenser Coil.

STAINLESS STEEL
INTERNAL EVAPORATOR
R-404 REFRIGERANT

SERVICE
 Panels easily removed and all components accessible for service.
 Removable/cleanable air filters.

Warranty valid in United States, Canada, Puerto Rico, & U.S. Territories. Contact Factory for Warranty in other Countries.

STORAGE BINS

- B-300 - 300 lb. Application Capacity (260 lb. ARI-Rated Capacity Bin)
- B-500 - 500 lb. Application Capacity (360 lb. ARI-Rated Capacity Bin)
- B-700 - 700 lb. Application Capacity (550 lb. ARI-Rated Capacity Bin)
- B-800 - 800 lb. Application Capacity (600 lb. ARI-Rated Capacity Bin)
- B-900 - 900 lb. Application Capacity (660 lb. ARI-Rated Capacity Bin)
- B-1200 - 1200 lb. Application Capacity
- B-1500 - 1500 lb. Application Capacity

ELECTRICAL & PLUMBING

- 115/60/1
- 20 amp Max Fuse/HACR Breaker Size
- 1/2" OD copper or equivalent independent potable water supply
- 3/4" independent drain connection

AIR - COOLED

Water Temp ° F.	50°	70°	90°
Air Temp ° F.	70°	499	468
	80°	475	427
	90°	468	393

WATER - COOLED

Water Temp ° F.	50°	70°	90°
Air Temp ° F.	70°	480	471
	80°	473	458
	90°	471	448

AIR - COOLED REMOTE

Water Temp ° F.	50°	70°	90°
Air Temp ° F.	70°	517	493
	80°	499	462
	90°	493	436

UTILITY CONSUMPTION

Model Number	Ice Production Per Cycle		KWH per 100 lbs.	Potable Water Gallons per 100 lbs.	Condenser Water Gallons per 100 lbs.
	Lbs.	Cubes			
KM-500MAH	9.5	480	7.4	28.8	NA
KM-500MWH	9.5	480	6.2	29.7	156
KM-500MRH	9.5	480	7.0	31.3	NA

SPECIFICATIONS

Model Number	Condenser	Amperage	Min. Circuit Ampacity	Shipping Weight
KM-500MAH	Air-Cooled	13.0	20	185 lbs.
KM-500MWH	Water-Cooled	10.0	20	185 lbs.
KM-500MRH	Air-Cooled Remote	15.0	20	185 lbs.

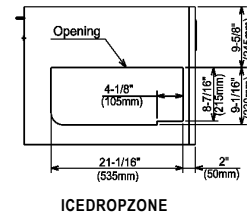
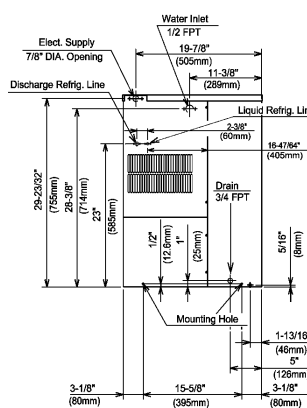
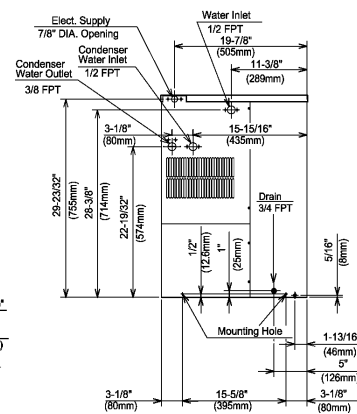
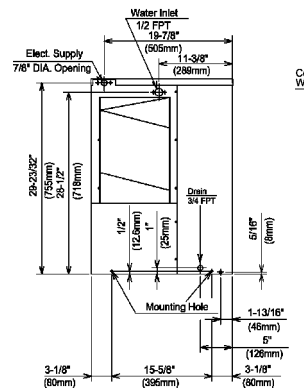
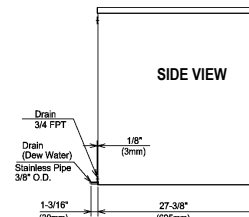
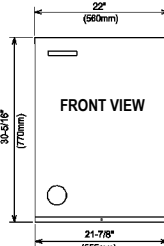
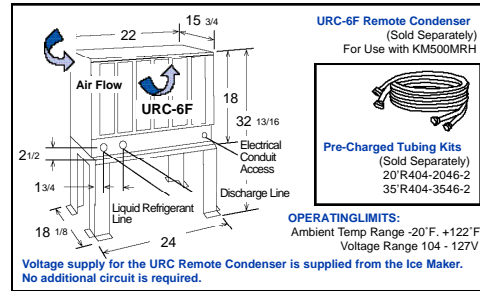

© HOSHIZAKI AMERICA, INC.

618 Hwy. 74 S., Peachtree City, GA30269 TEL1-800-438-6087

FAX 1-800-345-1325

www.hoshizaki.com

We reserve the right to change specifications without notice.

Printed in U.S.A.